

Korpus / Bobin ETD44 1s.18p. Pionowy / Vertical

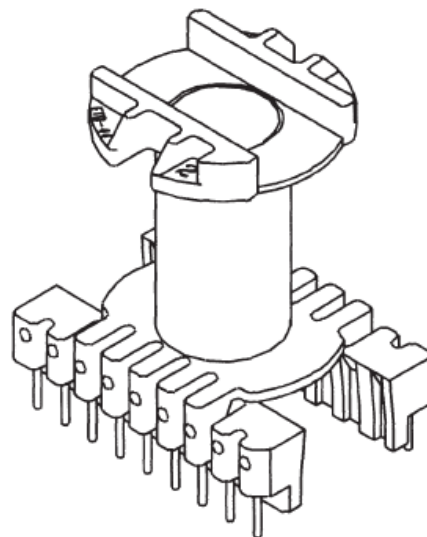
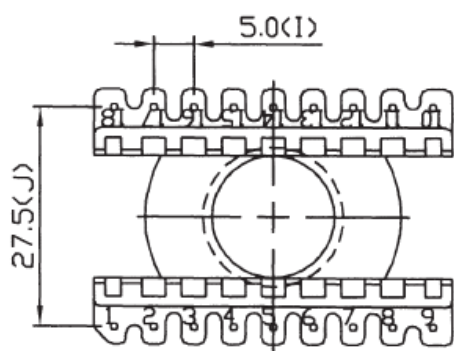
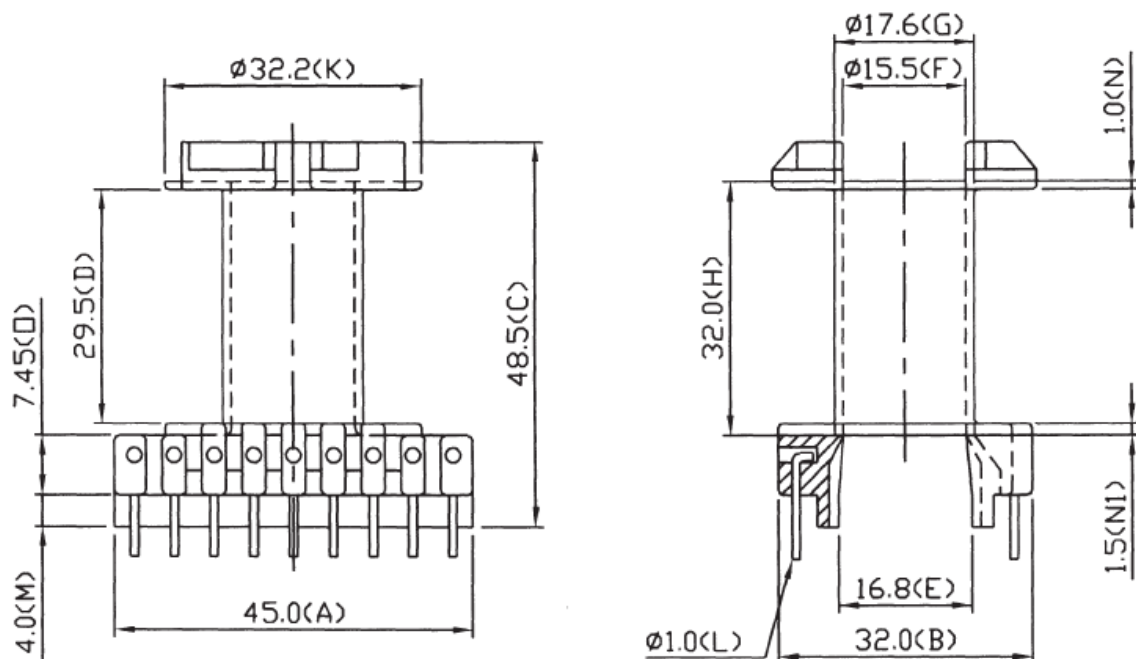

Tolerancja / Tolerance: $\pm 0,5\text{mm}$; X $\pm 0,3\text{mm}$; XX $\pm 0,2\text{mm}$
 Rozstaw pinów / Pin pitch: $\pm 0,2\text{mm}$