

Korpus / Bobin ETD49 1s.20p. Poziomy / Horizontal

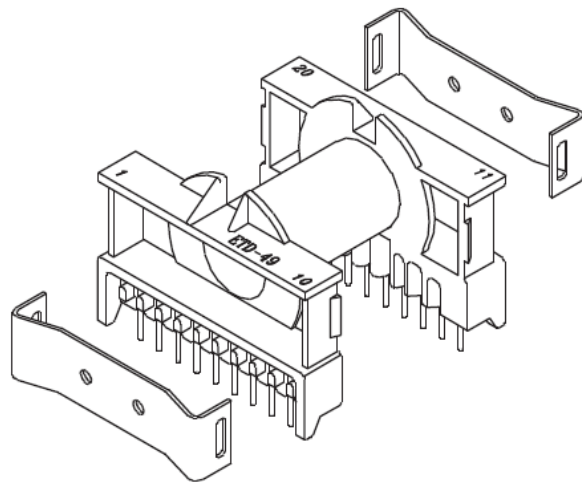
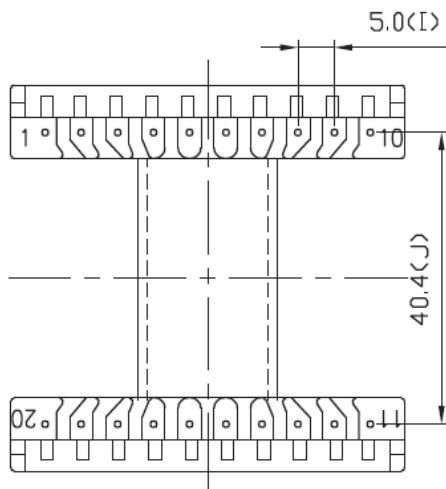
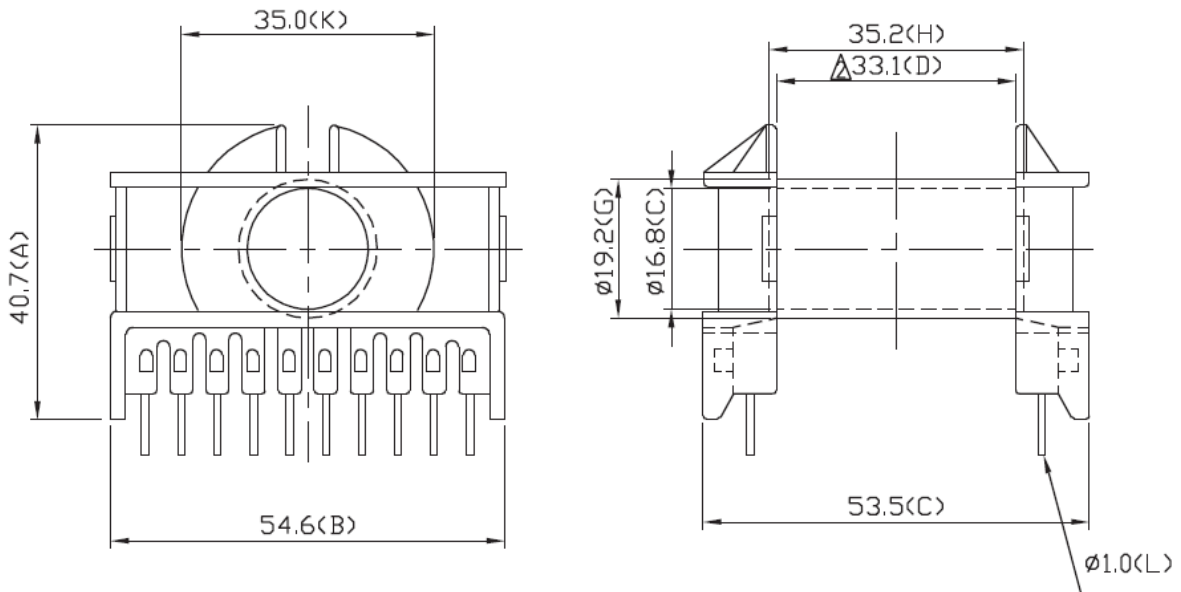

Tolerancja / Tolerance: $\pm 0,5\text{mm}$; X $\pm 0,3\text{mm}$; XX $\pm 0,2\text{mm}$
 Rozstaw pinów / Pin pitch: $\pm 0,1\text{mm}$