

Korpus / Bobbin E16/8/5 1s. 9p. Poziomy / Horizontal

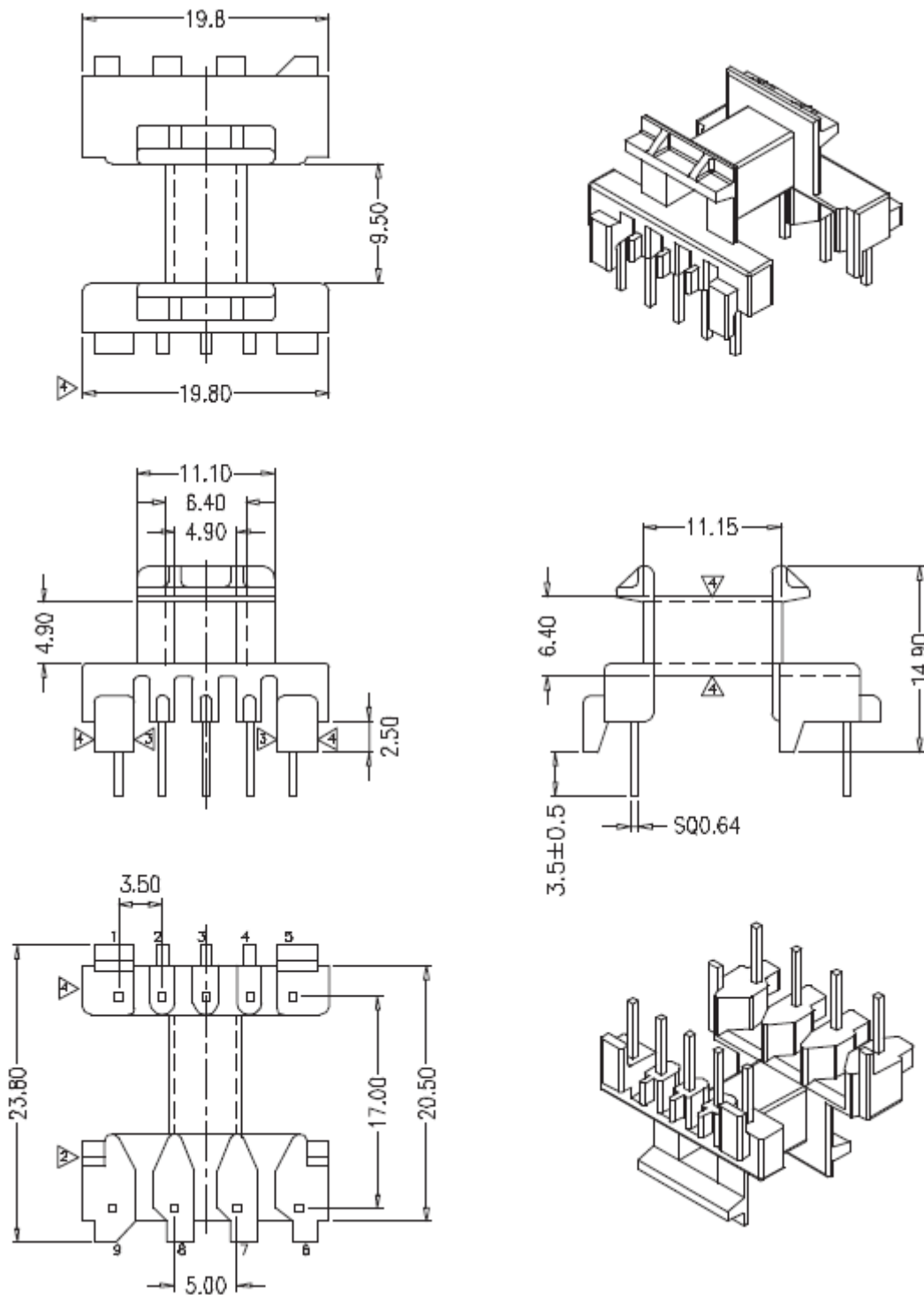

Tolerancja / Tolerance: $0 < L \leq 4 \pm 0,1$; $4 < L \leq 16 \pm 0,2$; $16 < L \leq 63 \pm 0,3$
 Rozstaw pinów / Pin pitch: $\pm 0,2\text{mm}$