

Korpus / Bobbin E20 1s.8p. Poziomy / Horizontal

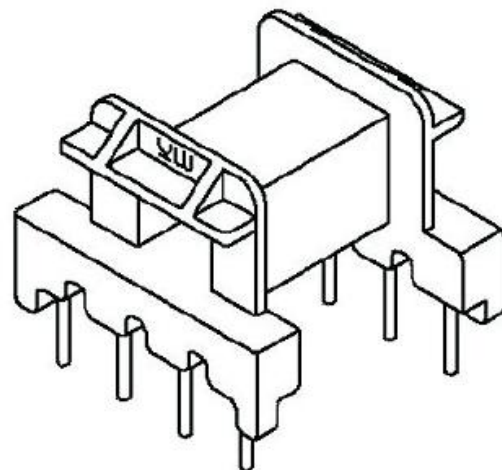
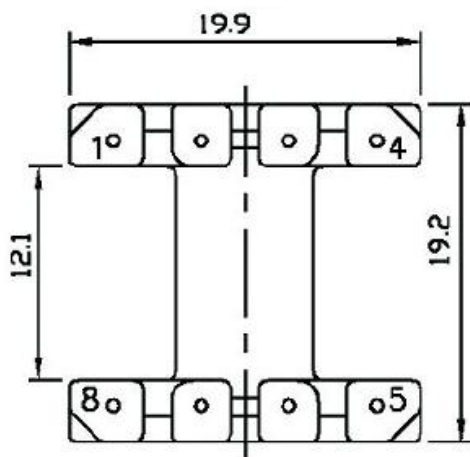
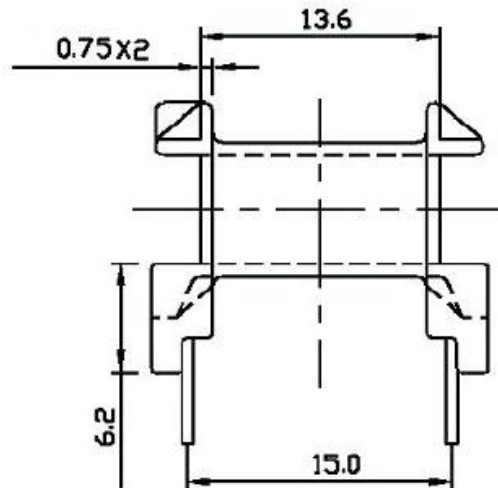
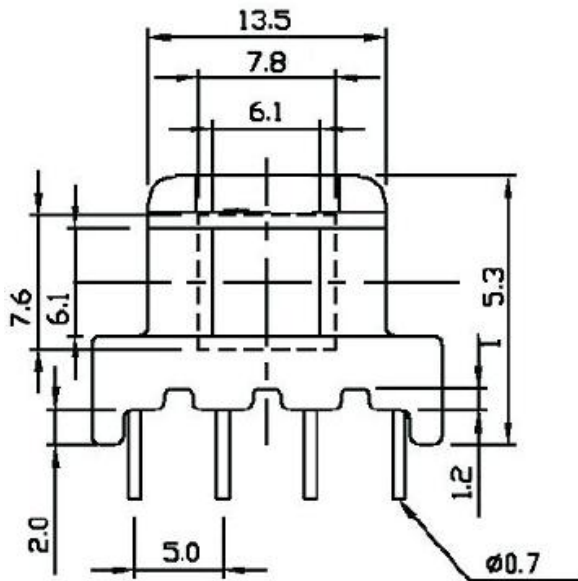

Tolerancja / Tolerance: $0 < L \leq 4 \pm 0,1$; $4 < L \leq 16 \pm 0,2$; $16 < L \leq 63 \pm 0,3$
Rozstaw pinów / Pin pitch: $\pm 0,2 \text{mm}$