

Korpus / Bobin E42/21/15 1s.12p. Poziomy / Horizontal

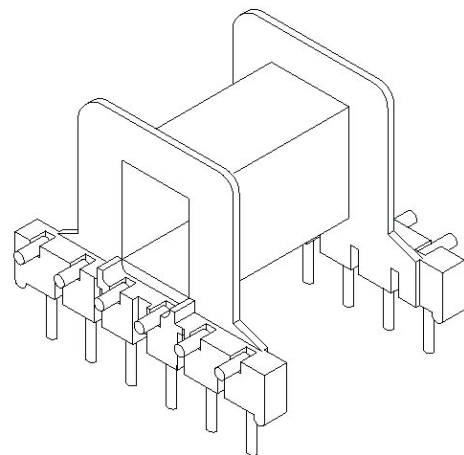
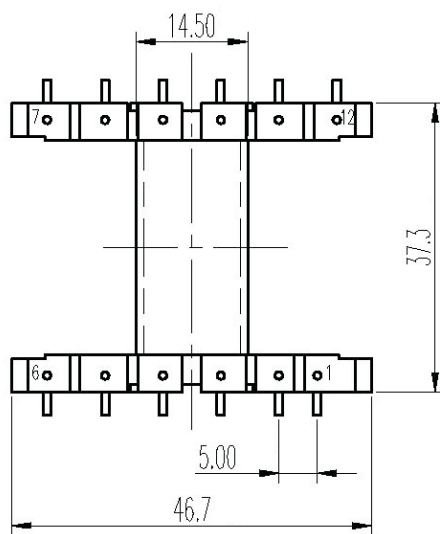
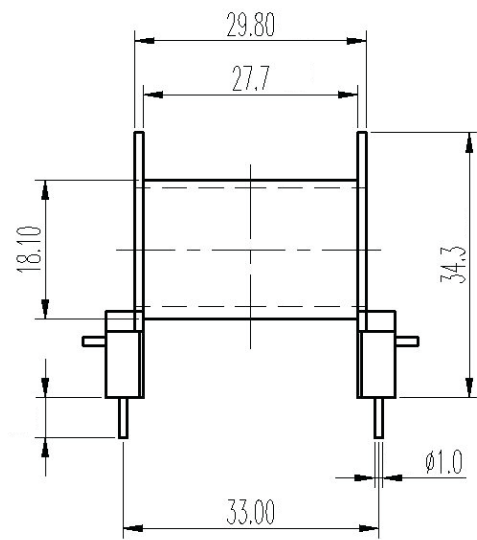
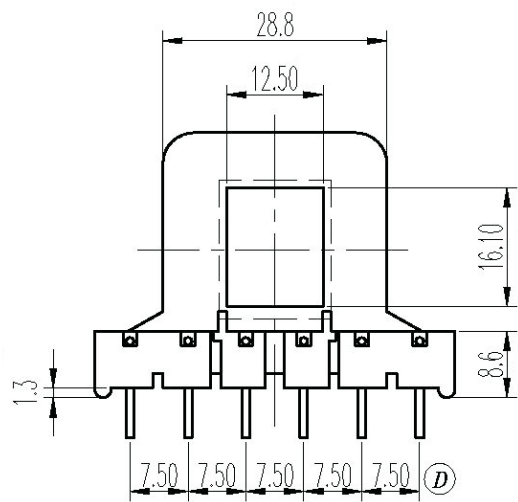

Tolerancja / Tolerance: $0 < L \leq 4 \pm 0,1$; $4 < L \leq 16 \pm 0,2$; $16 < L \leq 63 \pm 0,3$
Rozstaw pinów / Pin pitch: $\pm 0,2\text{mm}$