

# Korpus / Bobbin E42/21/15 1s.16p. Poziomy / Horizontal

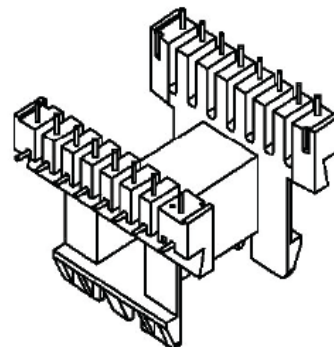
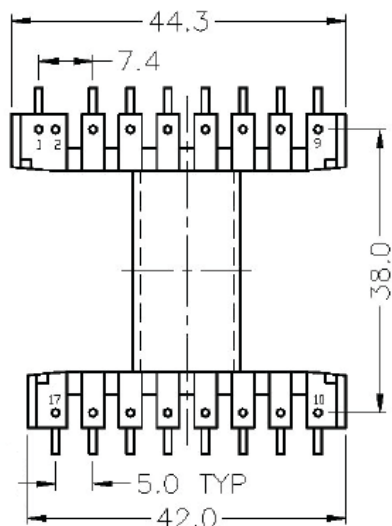
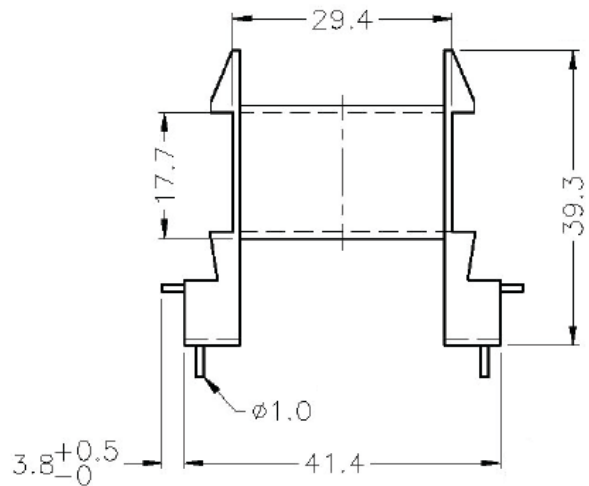
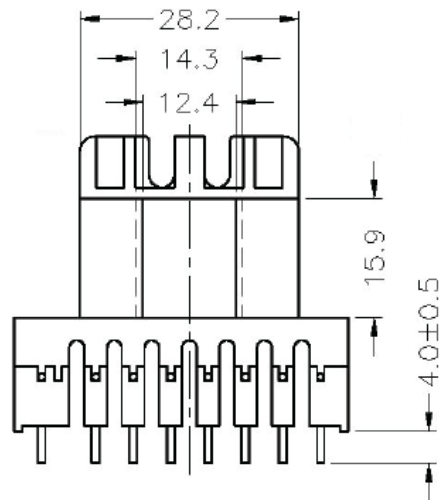
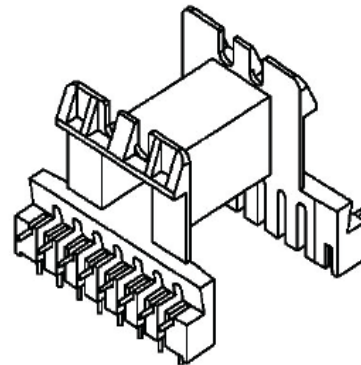
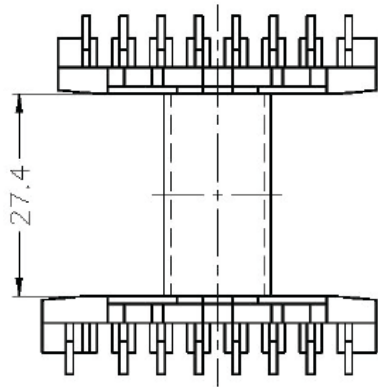

Tolerancja / Tolerance:  $0 < L \leq 4 \pm 0,1$ ;  $4 < L \leq 16 \pm 0,2$ ;  $16 < L \leq 63 \pm 0,3$   
 Rozstaw pinów / Pin pitch:  $\pm 0,2\text{mm}$