

Korpus / Bobin RM8 1s.12p. DIL

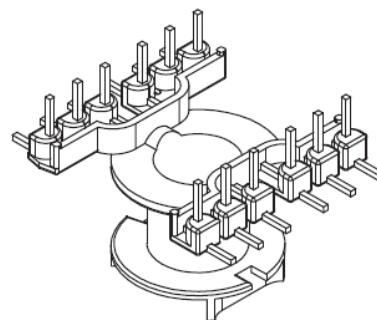
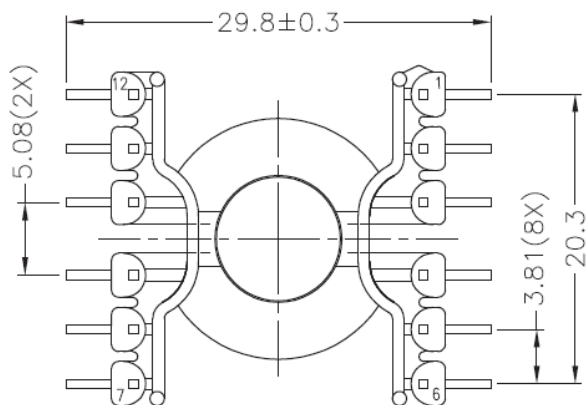
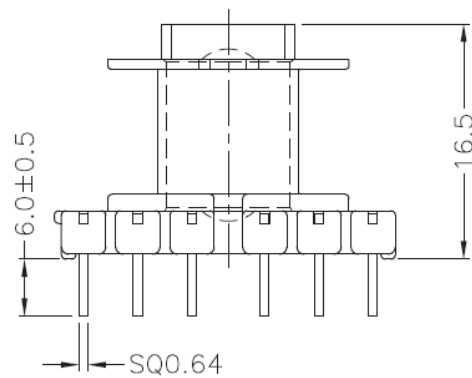
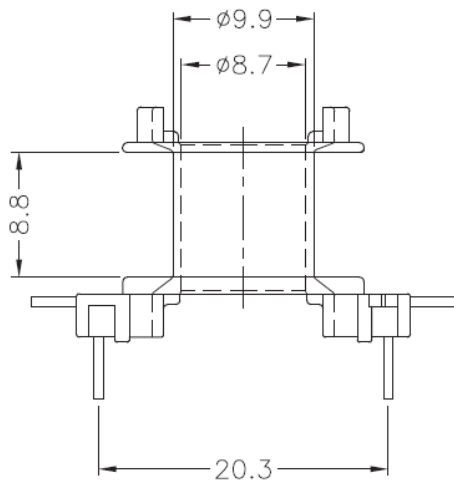
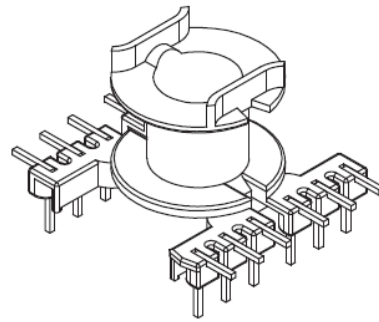
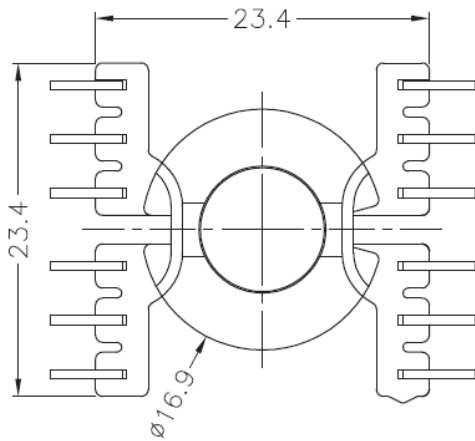

Tolerancja / Tolerance: $0 < L \leq 4 \pm 0,1 \text{ mm}$ $4 < L \leq 16 \pm 0,2 \text{ mm}$ $16 < L \leq 63 \pm 0,3 \text{ mm}$
Rozstaw pinów / Pin pitch $\pm 0,2 \text{ mm}$